

Flood Luminaires

PROJECT:

TYPE:

Product Image



Line Drawing

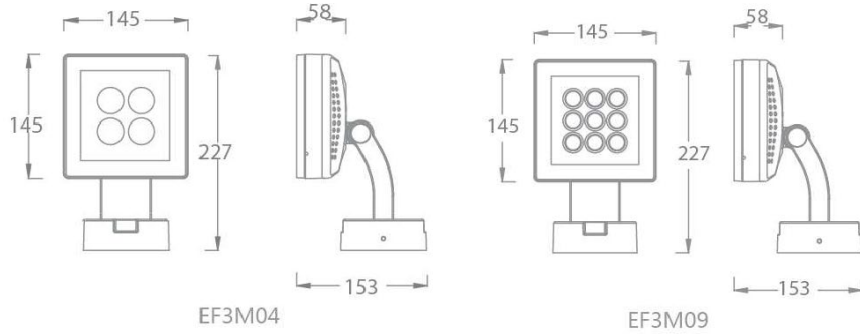

Product Description

SHINE PRO series is a professional LED floodlight designed by WAC for high-end outdoor lighting venues; Carefully designed with a unique appearance and a full glass surface design, it is simple and elegant, fashionable and beautiful, more suitable for current and future architectural trends. The lighting fixtures are equipped with hidden light modular design; Fully integrating the principles of aerodynamics, creating the optimal heat dissipation structure, enhancing the heat dissipation performance of lighting fixtures, and extending the service life of LED lighting fixtures; It can adjust the angle accurately in both vertical and horizontal directions, and the head of the lamp can also be adjusted from 0 to 90 degrees. The angle locking structure has been carefully designed to lock the adjustable projection direction; The SHINE PRO series lamps come in various sizes, angles, and powers to choose from, with a high display index of Ra90, which can meet different lighting application solutions.

Product Features

- Body Material: Aluminum alloy die-casting
- Optical System: Lens
- Finish: Static electricity powder coating
- Adjustable Angle: Vertical direction -30-150 °, horizontal direction 0-355 °
- Accessories: /
- Certification: CCC
- IP Rating: IP65
- Insulation Level: Class I
- Operating Temperature: -20°C~50°C

Product Specifications

- LED Type: HIGH POWER
- Light source power: 24W Max
- Luminous flux: 3000K 2660lm
- LED Lifetime: >50000h-L70 /B10-Ta25°C(LM-80/TM-21)
- CCT/CRI: MONO 2700K, 3000K, 4000K Ra90  
RGBW W=3000K, RGBW W=4000K, RGBW W=5700K
- SDCM: 3 SDCM (MONO) , 5 SDCM (RGBW)
- Input: 220V AC
- Dimming: ON-OFF / DMX512
- Net Weight: 2.5Kg, without packing

Order Model

Model	Power (W)	LEDs (quantity)	Max Lumens (lm)	Control Systems	Beam	CCT	Finish
AEF3M04	11 11W(Max)	4	717	EL ON-OFF 220V AC Power Supply	V 4°	27 2700K	BK Black
				ML DMX512 Dimming 220V AC Power Supply		30 3000K	
						40 4000K	

Example: AEF3M04-11EL-V27BK

Flood Luminaires

PROJECT:

TYPE:

Model	Power (W)	LEDs (quantity)	Max Lumens (lm)	Control Systems	Beam	CCT	Finish
<b>AEF3M09</b>	<b>24</b> 24W(Max)	9	1234	<b>EL</b> ON-OFF 220V AC Power Supply <b>ML</b> DMX512 Dimming 220V AC Power Supply	<b>S</b> 6° <b>1</b> 13° <b>2</b> 20° <b>3</b> 30° <b>J</b> 8°*27°	<b>27</b> 2700K <b>30</b> 3000K <b>40</b> 4000K	<b>BK</b> Black

Example: EF3M09-24EL-S27BK

Model	Power (W)	LEDs (quantity)	Max Lumens (lm)	Control Systems	Beam	CCT	Finish
<b>AEF3M09</b>	<b>22</b> 22W(Max)	9	782	<b>ML</b> DMX512 Dimming 220V AC Power Supply	<b>1</b> 19° <b>2</b> 29° <b>3</b> 37° <b>5</b> 53° <b>F</b> 23°X36°	<b>F3</b> RGBW W=3000K <b>F4</b> RGBW W=4000K <b>F6</b> RGBW W=5700K	<b>BK</b> Black

Example: AEF3M09-22ML-1F3BK

Accessories

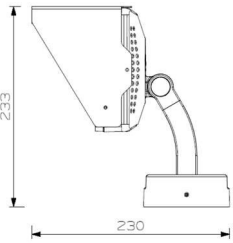
Model	Item	Description	Pic	Description Dimensions
AEF3M-WW1-BK	Wall Washer Visor	WW1		

LIGHT DISTRIBUTION@3000K LUMINAIRE DATA

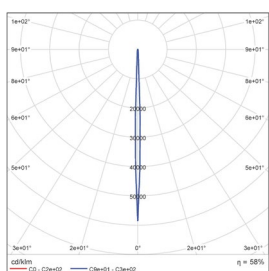

<b>MODEL:</b>	AEF3M04-11EL-V30BK
<b>BEAM ANGLE:</b>	4°
<b>POWER:</b>	14.5W
<b>LUMENS:</b>	717.3 lm
<b>CBCP:</b>	/
<b>EFFICACY:</b>	49.5 lm /W

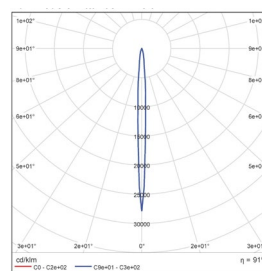

<b>MODEL:</b>	AEF3M09-24EL-S30BK
<b>BEAM ANGLE :</b>	6°
<b>POWER:</b>	27.7W
<b>LUMENS:</b>	1590 lm
<b>CBCP:</b>	/
<b>EFFICACY:</b>	57.7 lm /W

Flood Luminaires

PROJECT:

TYPE:

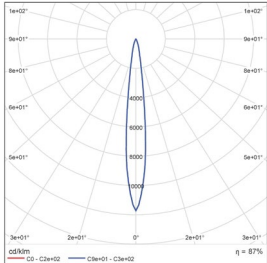

**MODEL:** AEF3M09-24EL-130BK  
**BEAM ANGLE:** 13°  
**POWER:** 27.6W  
**LUMENS:** 1532lm  
**CBCP:** /  
**EFFICACY:** 55.5lm/W

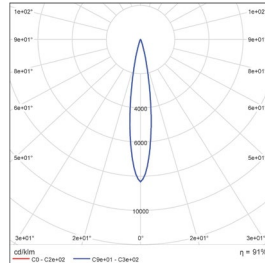

**MODEL:** AEF3M09-24EL-230BK  
**BEAM ANGLE:** 20°  
**POWER:** 27.6W  
**LUMENS:** 1657lm  
**CBCP:** /  
**EFFICACY:** 60lm/W

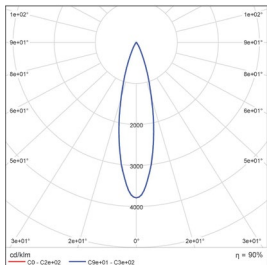

**MODEL:** AEF3M09-24EL-330BK  
**BEAM ANGLE:** 30°  
**POWER:** 27.6W  
**LUMENS:** 1654lm  
**CBCP:** /  
**EFFICACY:** 59.9m/W

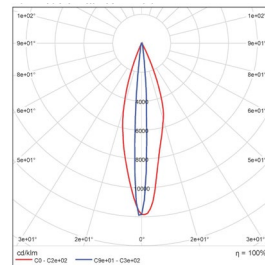

**MODEL:** AEF3M09-24EL-J30BK  
**BEAM ANGLE:** 8°\*27°  
**POWER:** 26.7W  
**LUMENS:** 1826lm  
**CBCP:** /  
**EFFICACY:** 66.5lm/W

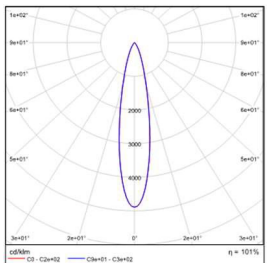

**MODEL:** AEF3M09-22ML-1F3BK  
**BEAM ANGLE:** 19°  
**POWER:** 22.4W  
**LUMENS:** 624lm  
**CBCP:** /  
**EFFICACY:** 27.8lm/W

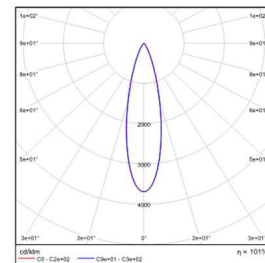

**MODEL:** AEF3M09-22ML-2F3BK  
**BEAM ANGLE:** 29°  
**POWER:** 22.5W  
**LUMENS:** 632lm  
**CBCP:** /  
**EFFICACY:** 28.1lm/W

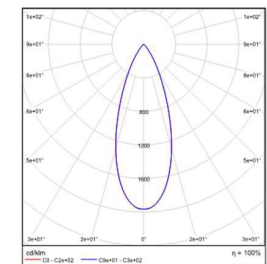

**MODEL:** AEF3M09-22ML-3F3BK  
**BEAM ANGLE:** 37°  
**POWER:** 22.6W  
**LUMENS:** 782lm  
**CBCP:** /  
**EFFICACY:** 34.6lm/W

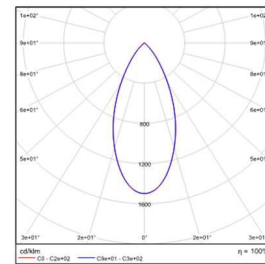

**MODEL:** AEF3M09-22ML-5F3BK  
**BEAM ANGLE:** 53°  
**POWER:** 23.9W  
**LUMENS:** 621lm  
**CBCP:** /  
**EFFICACY:** 26m/W